







**cod. 94289**

Number	Picture	QTY	Number	Picture	QTY
①		15	⑤		16
②		20	A		12
③		2			
④		5		 Cover	1

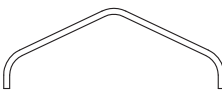
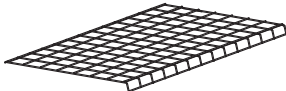

 **papillon**

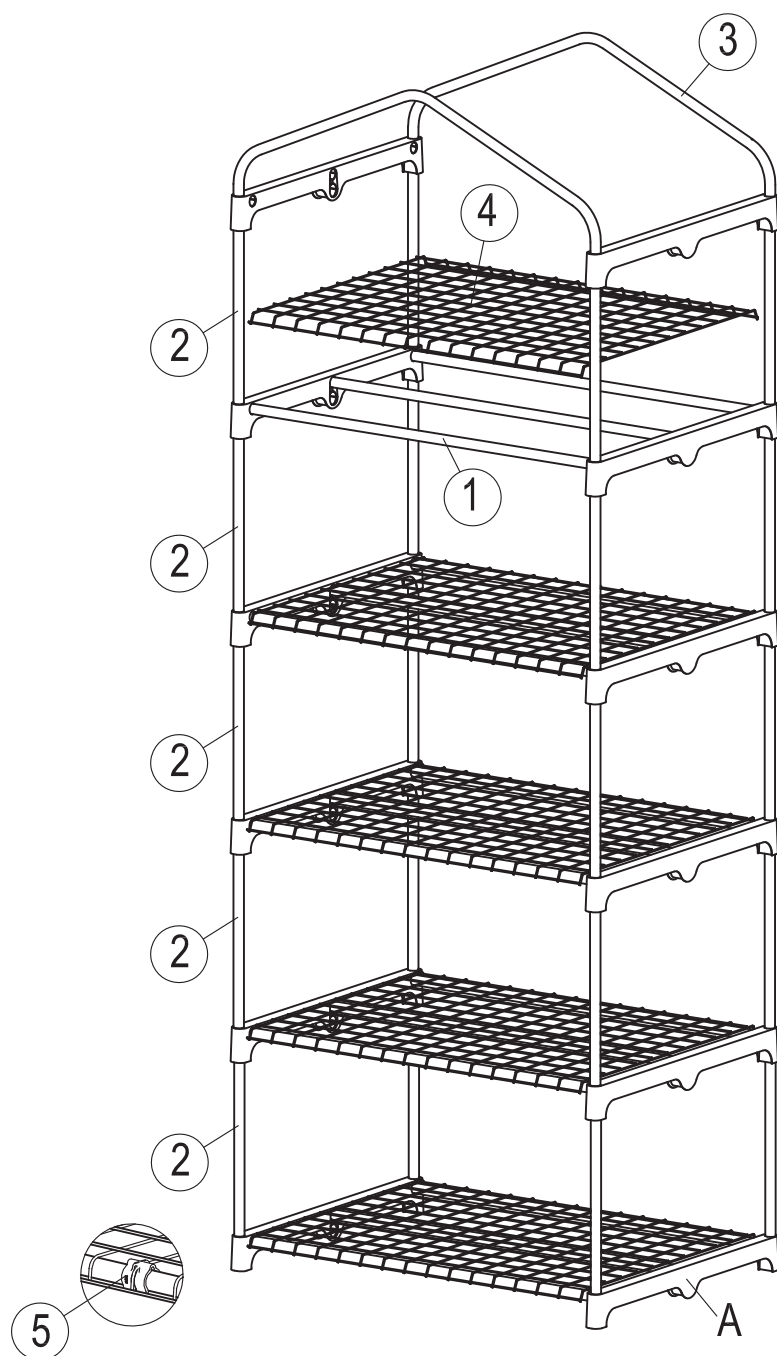
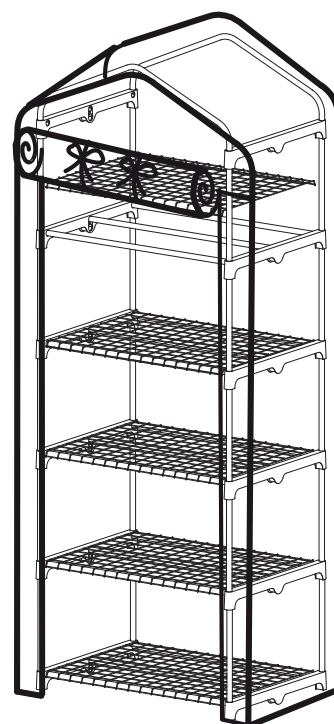

Verificare con attenzione la corrispondenza (vedi tabella) prima di procedere all'assemblaggio.  
 Check carefully the correspondence (see table) before proceeding with the assembly.  
 Verifique cuidadosamente la correspondencia (ver tabla) antes de proceder con el montaje.

DISTRIBUZIONE  
**FERRITALIA PRO**  
 FERRITALIA SOC. COOP.  
 Via Longhin, 71 - 35129 PADOVA  
[www.ferritalia.it](http://www.ferritalia.it)